

Date:	Project Name:
Type:	Part Number:



ORION SERIES

LED UFO HIGHBAY



DESCRIPTION

Our new generation LED highbays are ideal for replacing HID High Bay fixtures, offering high performance and long life. Designed precision spherical and convex lens and offers low brightness, uniform illumination and high efficiency LED platform. Designed with easy installation of sensors at the face of the fixture.

FEATURES

- DLC Premium
- Excellent heat dissipation
- 0-10V Dimming
- Mounting options: hook/chain, pole pendent and surface mounting
- Operating temperature: 4°F to +122°F (-20°C to +50°C)
- Dual Voltage 120-347V
- Suitable for wet locations IP65 rated
- Efficacy 160lm/W
- Multi CCT & Wattage
- Built-in 8KVA Surge Protection
- Rated Lifetime L70(hrs): >70,000
- Includes 10' cord, ring bolt mounting accessory & safety hanging kit
- 7 year warranty

APPLICATIONS

-  Commercial Building
-  Industrial/Warehouse
-  Retail Facility



Date:	Project Name:
Type:	Part Number:

SPECIFICATION

ORDER#	MODEL#	WATTS	VOLTAGE (V)	CCT (K)	LUMENS	EFFICACY	CRI
R34214	RENO-HBU-120W-DV-MCCT-G2-R1	60W	120-347V	3000K	9000 lm	150 lm/W	>80
		80W			12,000 lm		
		100W			15,000 lm		
		120W			18,000 lm		
		60W		4000K	10,200 lm	170 lm/W	
		80W			13,600 lm		
		100W			17,000 lm		
		120W			20,400 lm		
		60W		5000K	9600 lm	160 lm/W	
		80W			12,800 lm		
		100W			16,000 lm		
		120W			19,200 lm		
R34215	RENO-HBU-160W-DV-MCCT-G2-R2	80W	120-347V	3000K	12,000 lm	150 lm/W	>80
		100W			15,000 lm		
		120W			18,000 lm		
		160W			24,000 lm		
		80W		4000K	13,600 lm	170 lm/W	
		100W			17,000 lm		
		120W			20,400 lm		
		160W			27,200 lm		
		80W		5000K	12,800 lm	160 lm/W	
		100W			16,000 lm		
		120W			19,200 lm		
		160W			25,600 lm		

Date:	Project Name:
Type:	Part Number:

SPECIFICATION CON'T

ORDER#	MODEL#	WATTS	VOLTAGE (V)	CCT (K)	LUMENS	EFFICACY	CRI
R34216	RENO-HBU-250W-DV-MCCT-G2-R3	120W	120-347V	3000K	18,000 lm	150 lm/W	>80
		150W			24,000 lm		
		200W			30,000 lm		
		250W			37,500 lm		
		120W		4000K	20,400 lm	170 lm/W	
		150W			27,200 lm		
		200W			34,000 lm		
		250W			42,500 lm		
		120W		5000K	19,200 lm	160 lm/W	
		150W			24,000 lm		
		200W			32,000 lm		
		250W			40,000 lm		
R34217	RENO-HBU-320W-DV-MCCT-G2-R4	250W	120-347V	4000K	41,250 lm	165 lm/W	>80
		280W			46,200 lm		
		300W			49,500 lm		
		320W			52,800 lm		
		250W		5000K	40,000 lm	160 lm/W	
		280W			44,800 lm		
		300W			44,800 lm		
		320W			51,200 lm		

ACCESSORIES

ORDER#	MODEL#	DESCRIPTION
R39601	RENO-HBU-COVER-R1/R2	PC Reflector Lens for R1/R2 UFO HIGHBAY
R39603	RENO-HBU-COVER-R3/R4	PC Reflector Lens for R3/R4 UFO HIGHBAY
R39602	RENO-HBU-BOTTOM-R1/R2	PC Reflector bottom cover for R1/R2 UFO HIGHBAY
R39605	RENO-HBU-BOTTOM-R3/R4	PC Reflector bottom cover for R3/R4 UFO HIGHBAY
R83005	RENO-EM-40RM	Emergency LED Driver
R34601	RENO-HUB-YOKE-G2-R1/R2/R3	Yoke Mount for UFO HIGHBAY R1/R2/R3
R34602	RENO-HUB-YOKE-G2-R4	Yoke Mount for UFO HIGHBAY R4

Date:	Project Name:
Type:	Part Number:



RENO-HBU-COVER-R1/R2



RENO-HBU-COVER-R3/R4



RENO-HBU-BOTTOM-R1/R2



RENO-HBU-BOTTOM-R3/R4



RENO-EM-40RM



RENO-HUB-YOKE-G2-R1/R2/R3



RENO-HUB-YOKE-G2-R4

SENSOR & REMOTE OPTIONS

ORDER#	MODEL#	DESCRIPTION
R71002	RENO-SENSOR-MW-H	Dimming Microwave Sensor
R73002	RENO-REMOTE-H	Controller for Bi-Level Sensor (With Screen)
R73005	RENO-REMOTE-H-ECO	ECO Remote Control for Bi-Level Sensor (without screen)



RENO-SENSOR-MW-H



RENO-REMOTE-H



RENO-REMOTE-H-ECO

Date:	Project Name:
Type:	Part Number:

DIMENSIONS

R1 & R2

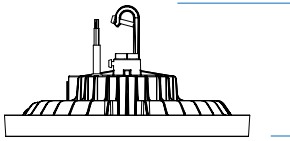

146.7mm
(5.8")

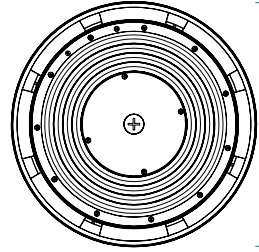

Ø275mm (Ø10.8")

R3

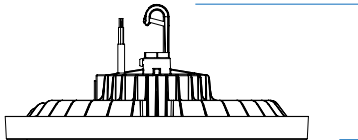

151.4mm
(6")

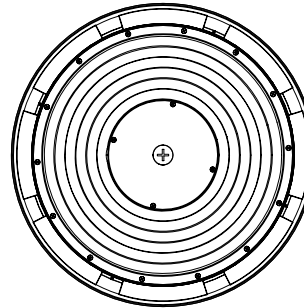

Ø340mm (Ø13.4")

R4

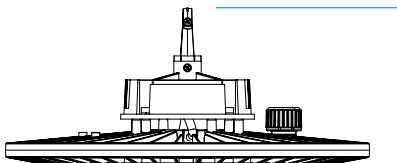

176.2mm
(7")

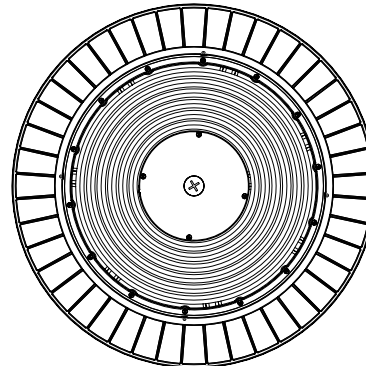

Ø408mm (Ø16.1")