

**LED BOLLARD FIXTURES**

**INSTALLATION INSTRUCTIONS**

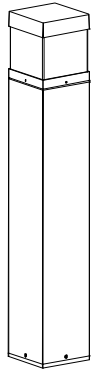

1. Open the package. The package contains A and B.



A. Fixture

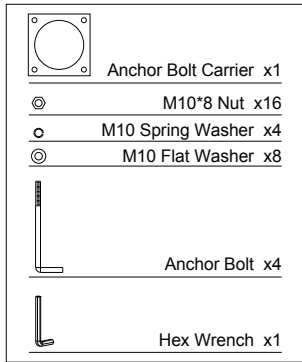

B. Accessories Package

**Please read and understand this entire manual before attempting to assemble, operate or install the product.**



**WARNING: RISK OF FIRE, ELECTRIC SHOCK, INJURY OR PROPERTY DAMAGE.**

1. Risk of electric shock--Disconnect power to equipment before installing or servicing. This equipment must be installed according to all applicable codes & ordinances.
2. Installation and service of this equipment must be performed by qualified service personnel.
3. Read these instructions before installing, servicing or maintaining this equipment.
4. The installer must ensure that the foundation is stable and can support the luminaire's weight.
5. The Installer must use proper means to secure the luminaire to the ground.

**CAUTION:**

1. Edges may cut--wear gloves while handling or servicing this equipment.
2. Inspect equipment for damage from shipping and handling.
3. Recommended cleaning substances: Wipe off dust with a dry, soft cloth. Remove greasy spots etc. with a soft cloth dampened in lukewarm water (<122° F/ 50° C) with a mild detergent.
4. This fixture requires a 120-277Vac power source.
5. Operating temperature -40° C to 50° C (-40° F to 122° F).
6. Suitable for wet locations.

This device complies with FCC Part 15 Subpart B. Operation is subject to the following two conditions: (1) this device may not cause harmful interference, and (2) this device must accept any interference received, including that may cause undesired operation.

*Retain these instructions for future maintenance reference.*

**Bollard Installation**

2. Get the anchor bolt carrier assembled as **Fig. 1** and use it to determine placement of anchor bolts in concrete.

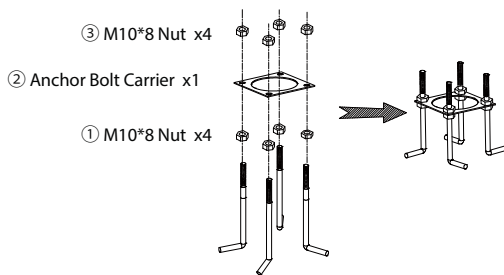

**Fig 1**

3. Install 4 anchor bolts into concrete as per attached **Fig. 2**, having at least 1-1/2~2" protruding from concrete with threads free and clear of debris and dirt (Electrical conduit are reserved in the concrete center).

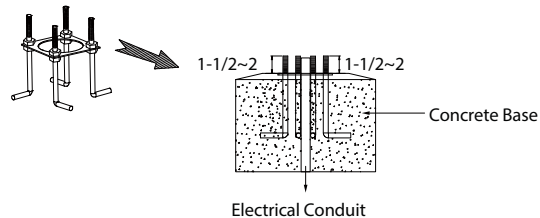

**Fig 2**

4. Using the hex wrench, loosen the 4 screws on the side of the head, and open the top head. **Fig. 3**

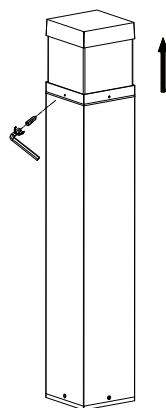

**Fig 3**

5. Select desired wattage & CCT, select desired PC on/off, through the dial switches on the driver box cover plate. **Fig. 4**

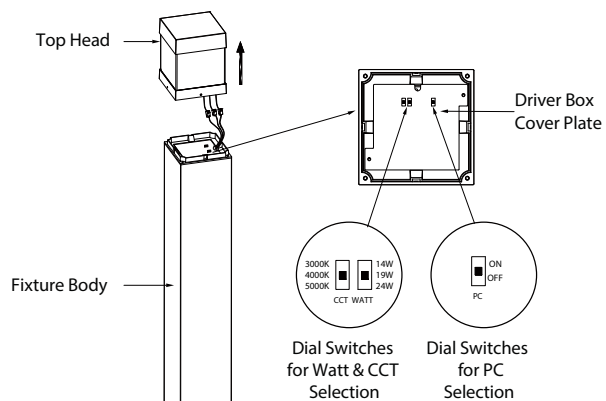
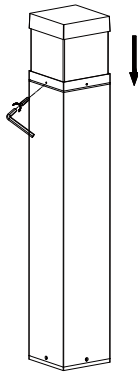

**Fig 4**

**LED BOLLARD FIXTURES**

**INSTALLATION INSTRUCTIONS**

6. Put the top head back on and tighten the 4 screws.  
**Fig. 5**



**Fig 5**

7. Using the hex wrench, loosen the 4 screws on the side of the bottom, and separate the fixture body from the mounting base. **Fig. 6**

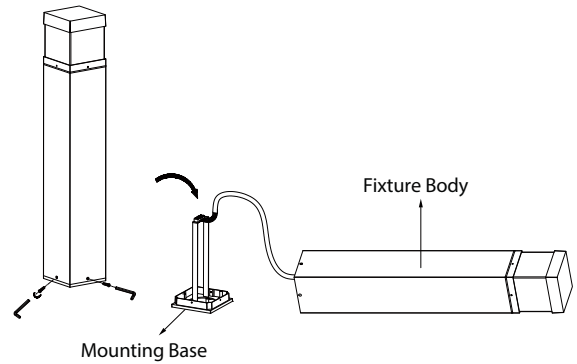

**Fig 6**

8. Place bollard mounting base over anchor bolts, and tighten M10 flat washer, M10 spring washer & M10\*8 nuts **Fig. 7** securing the mounting base to the foundation.

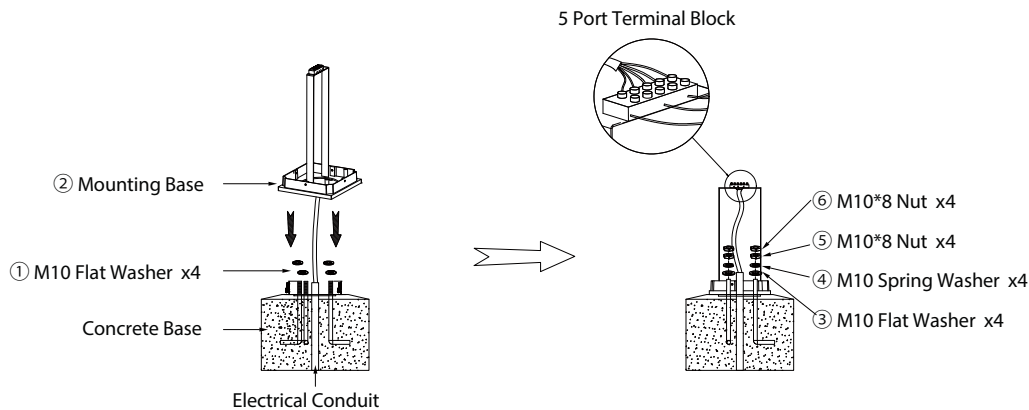

**Fig 7**

9. Connect the wires, then tighten the terminal block with a flat-head screwdriver, and check to make sure all wires are in good connection **Fig. 8**.

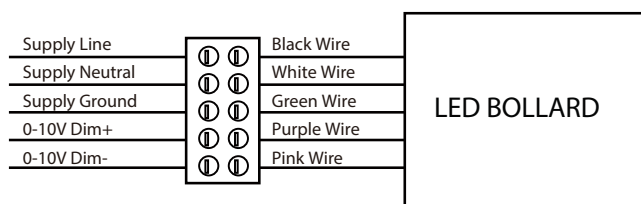

**Fig 8**

10. Put the fixture body back on and tighten the 4 screws **Fig. 9**.

11. Installation complete.

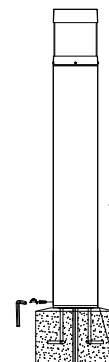

**Fig 9**

## ANCHOR BOLT TEMPLATE FOR BOLLARD

Confirm dimensions before using as a template. If possible use the actual mounting plate as your template.

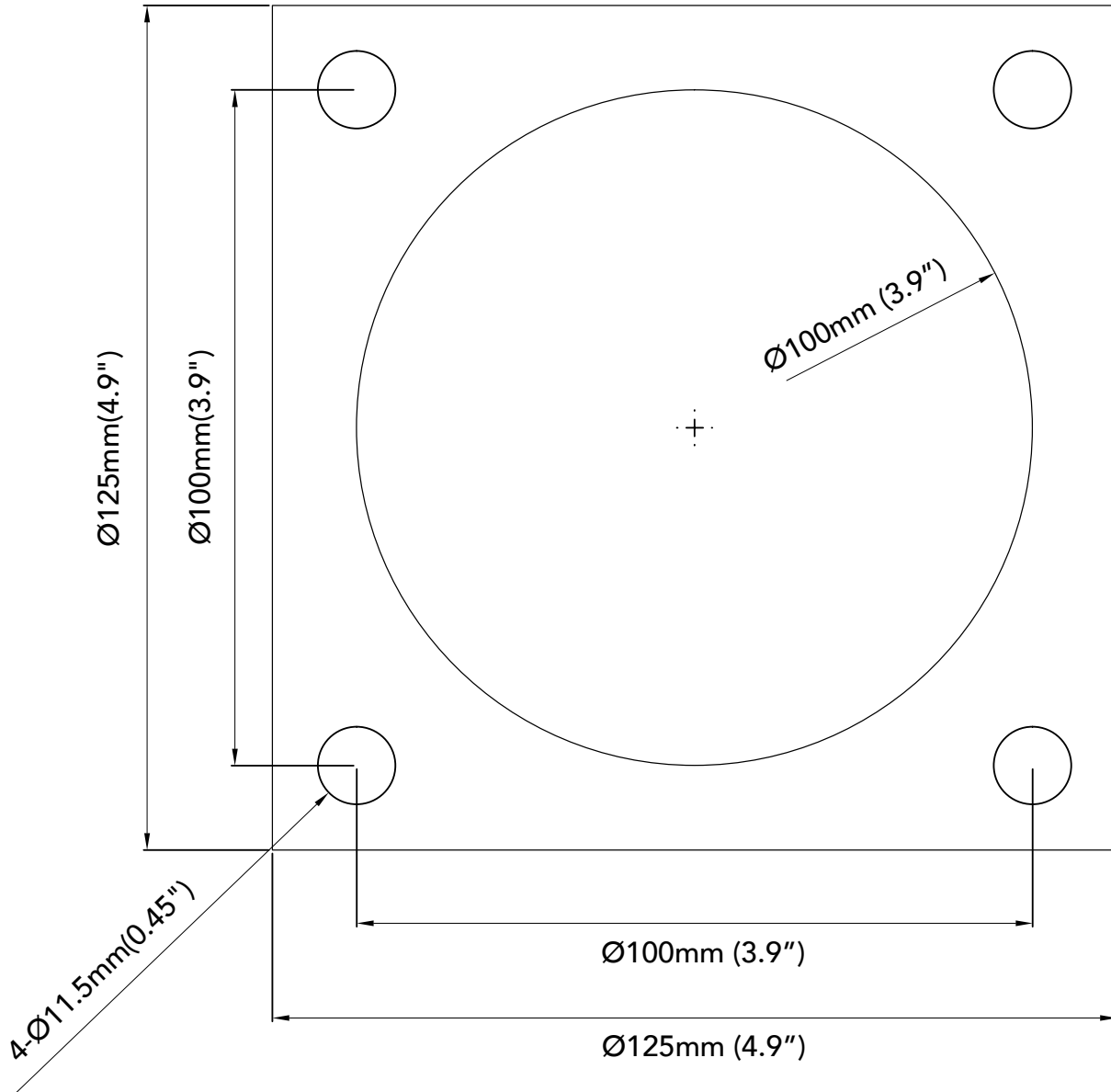

# SQUARE