

5" (AC) OUTDOOR SLIM ROUND - 5CCT SELECTABLE

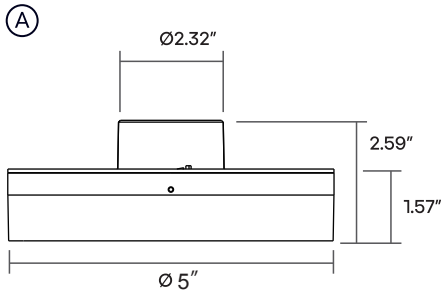

PART	DESCRIPTION	QTY
A	5" OUTDOOR SLIM	1
B	MOUNTING PLATE	1
C	MOUNTING SCREWS	2
D	WIRE NUTS	3

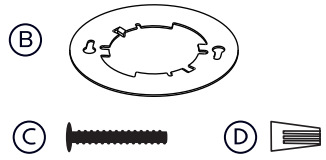

TOOLS AND MATERIALS REQUIRED



SAFETY RECOMMENDATIONS

1. TURN OFF ELECTRICAL POWER BEFORE STARTING INSTALLATION.
2. THIS PRODUCT MUST BE INSTALLED IN ACCORDANCE WITH THE APPLICABLE INSTALLATION CODE BY A PERSON FAMILIAR WITH THE CONSTRUCTION AND OPERATION OF THE PRODUCT AND THE HAZARDS INVOLVED.
3. CAUTION: RISK OF FIRE. CONSULT A QUALIFIED ELECTRICIAN TO ENSURE CORRECT BRANCH CIRCUIT CONDUCTOR.
4. FOR EXTERNAL USE ONLY: IT IS RECOMMENDED TO APPLY WATERPROOF SILICONE TO SEAL AROUND TRIM AND CEILING.

INSTALLATION INSTRUCTIONS

1. Prior to installation, install two screws (furnished) pass through the T-shaped mounting plate into the j-box. Drive the screws completely to the end of the j-box.

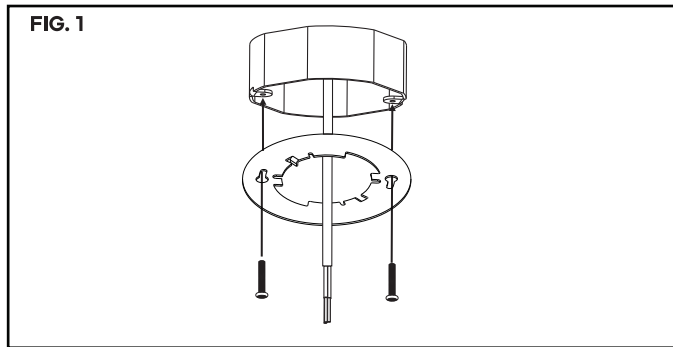

2. Connect supply wires to wires in fixture wiring box with proper size wire nuts or push wires into "push-in" connector. Connect the white to white, black to black and green to green.

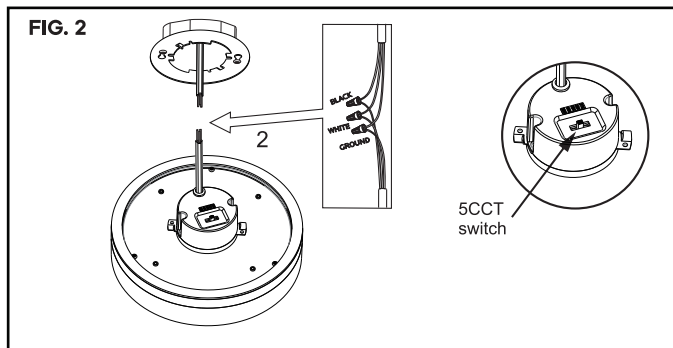

3. First keep the two buckle lugs in the gap on the mounting disc. And put the guide post in the center of the lamp body to the convex hole on the mounting plate, keep the center position consistent, and then push up the lamp body flat. Finally rotate the lamp body to the right and lock the light.

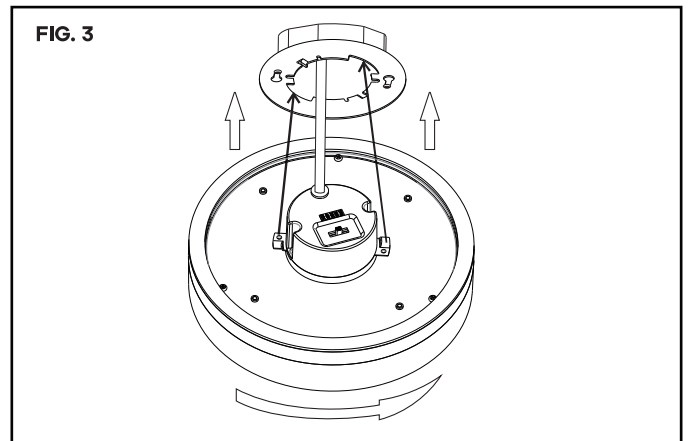

4. Installation complete.

