

Date: _____ Project: _____

Type: _____ Part #: _____



Aerolux

Field-Adjustable Distribution Area Light

Meet the AEROLUX SERIES Beam Adjustable Area light built for real-world outdoor lighting.

With 4-way field-adjustable distribution (T2-T5), you can fine-tune the beam pattern on-site in seconds, meaning one fixture can handle multiple layouts without over-lighting, spill light, or the “wrong optic” panic.

It’s the ideal solution for projects where flexibility, clean coverage, and future-proof planning matter.



Product Features

- DLC premium (pending)
- Reno Standalone and Smart sensor capable
- Hermetic Seal Assurance: Integrated breather valve enables 100% airtight testing, ensuring long-term waterproof reliability
- Reduces Structural Stress: Lighter weight and compact profile minimize load on mounting poles
- Die-cast aluminum body in black/bronze/white finish
- Custom Colours Available
- Polycarbonate lens
- 4-Way field-adjustable switch for distribution T2/T3/T4/T5 (using BeamFlex™ Technology without swapping lenses)
- DarkSky approved at 3000K only
- IP65 rated for wet location
- 20KVA surge suppression
- Includes an adapter for round pole installations
- Operating temp: -40°F to 113°F (-40°C to 45°C)
- Rated Lifetime L70(hrs): >100,000
- 10 Year Limited Warranty

Specifications

Voltage	120-347V AC
Wattage	R1: 90/120/150W (default 150W) R2: 180/240/300W (default 300W)
CCT	3000K, 4000K, 5000K (default 5000K)
THD	< 20%
Power Factor	> 0.9
CRI	83
Lumens	Up to 55,463 lm
Efficacy	Up to 193 lm/W
Beam Angle	Selectable T2/T3/T4/T5 (default T3)
Mounting	Round or Square Pole-Mounted
Applications	Commercial buildings, Malls, Car Dealerships, Retail, Parking lots
Certifications	DLC Premium, UL, IP65,

Specifications

Order #	Model #	Voltage	Wattage	Lumens	Efficacy	CCT	Finish
R53061	RENO-AEROLUX-SB-MW-DV-MCCT-ABA-R1-BK	120-347V	90/120/150W	Up to 27,745 lm	Up to 187 lm/W	30/40/5000K	Black
R53062	RENO-AEROLUX-SB-MW-DV-MCCT-ABA-R1-WH	120-347V	90/120/150W	Up to 27,745 lm	Up to 187 lm/W	30/40/5000K	White
R53063	RENO-AEROLUX-SB-MW-DV-MCCT-ABA-R1-BRN	120-347V	90/120/150W	Up to 27,745 lm	Up to 187 lm/W	30/40/5000K	Bronze
R53064	RENO-AEROLUX-SB-MW-DV-MCCT-ABA-R2-BK	120-347V	180/240/300W	Up to 55,463 lm	Up to 193 lm/W	30/40/5000K	Black
R53065	RENO-AEROLUX-SB-MW-DV-MCCT-ABA-R2-WH	120-347V	180/240/300W	Up to 55,463 lm	Up to 193 lm/W	30/40/5000K	White
R53066	RENO-AEROLUX-SB-MW-DV-MCCT-ABA-R2-BRN	120-347V	180/240/300W	Up to 55,463 lm	Up to 193 lm/W	30/40/5000K	Bronze

Light Distribution R1 (R53061, R53062, R53063)

	3000K				4000K				5000K			
	T2	T3	T4	T5	T2	T3	T4	T5	T2	T3	T4	T5
90W	15,338 lm	15,789 lm	16,684 lm	15,949 lm	16,417 lm	16,468 lm	17,231 lm	17,005 lm	16,227 lm	16,883 lm	17,501 lm	16,950 lm
	170.4 lm/W	175.4 lm/W	185.3 lm/W	177.2 lm/W	182.4 lm/W	182.9 lm/W	191.4 lm/W	188.9 lm/W	180.3 lm/W	187.5 lm/W	194.4 lm/W	188.3 lm/W
120W	20,316 lm	21,178 lm	21,134 lm	19,339 lm	21,459 lm	21,975 lm	21,920 lm	20,802 lm	20,982 lm	22,248 lm	21,467 lm	20,726 lm
	169.3 lm/W	176.4 lm/W	176.1 lm/W	161.1 lm/W	178.8 lm/W	183.1 lm/W	182.6 lm/W	173.3 lm/W	174.8 lm/W	185.4 lm/W	178.8 lm/W	17237 lm/W
150W	24,475 lm	26,257 lm	25,576 lm	24,726 lm	26,745 lm	27,745 lm	26,470 lm	26,275 lm	25,717 lm	27,353 lm	25,959 lm	24,713 lm
	163.1 lm/W	175 lm/W	170.5 lm/W	164.8 lm/W	178.3 lm/W	184.9 lm/W	176.4 lm/W	175.1 lm/W	171.4 lm/W	182.3 lm/W	173 lm/W	164.7 lm/W

Light Distribution R2 (R53064, R53065, R53066)

	3000K				4000K				5000K			
	T2	T3	T4	T5	T2	T3	T4	T5	T2	T3	T4	T5
180W	32,829 lm	34,072 lm	33,974 lm	32,846 lm	34,101 lm	34,747 lm	34,888 lm	34,311 lm	33,131 lm	34,514 lm	34,470 lm	33,355 lm
	182.4 lm/W	189.3 lm/W	188.7 lm/W	182.5 lm/W	189.5 lm/W	193.0 lm/W	193.8 lm/W	190.6 lm/W	184.1 lm/W	191.7 lm/W	191.5 lm/W	185.3 lm/W
240W	41,690 lm	43,938 lm	43,850 lm	41,931 lm	44,074 lm	45,380 lm	45,220 lm	44,265 lm	42,064 lm	44,354 lm	44,346 lm	42,345 lm
	173.7 lm/W	183.1 lm/W	182.7 lm/W	174.7 lm/W	183.6 lm/W	189.1 lm/W	188.4 lm/W	184.4 lm/W	175.3 lm/W	184.8 lm/W	184.8 lm/W	176.4 lm/W
300W	49,173 lm	52,619 lm	53,595 lm	49,712 lm	53,681 lm	55,463 lm	55,254 lm	54,215 lm	50,576 lm	54,027 lm	53,884 lm	50,930 lm
	163.9 lm/W	175.4 lm/W	178.7 lm/W	165.7 lm/W	178.9 lm/W	184.9 lm/W	184.2 lm/W	180.7 lm/W	168.6 lm/W	180.1 lm/W	179.6 lm/W	169.8 lm/W

BUG Rating

Order #	Model #	Wattage	T2	T3	T4	T5
R53061	RENO-AEROLUX-SB-MW-DV-MCCT-ABA-R1-BK	90W	B3-U0-G3	B3-U0-G3	B3-U0-G3	B3-U0-G2
R53062	RENO-AEROLUX-SB-MW-DV-MCCT-ABA-R1-WH	120W	B3-U0-G3	B3-U0-G4	B3-U0-G4	B3-U0-G2
R53063	RENO-AEROLUX-SB-MW-DV-MCCT-ABA-R1-BRN	150W	B3-U0-G4	B3-U0-G4	B3-U0-G4	B3-U0-G2
R53064	RENO-AEROLUX-SB-MW-DV-MCCT-ABA-R2-BK	180W	B3-U0-G3	B3-U0-G4	B3-U0-G4	B3-U0-G3
R53065	RENO-AEROLUX-SB-MW-DV-MCCT-ABA-R2-WH	240W	B3-U0-G3	B3-U0-G5	B3-U0-G5	B3-U0-G3
R53066	RENO-AEROLUX-SB-MW-DV-MCCT-ABA-R2-BRN	300W	B3-U0-G5	B3-U0-G5	B3-U0-G5	B3-U0-G4

DLC Certification

Model #	Application	DLC Standard	DLC Premium
RENO-AEROLUX-SB-MW-DV-MCCT-ABA-R1-BK	Outdoor Pole/Arm-Mounted Area and Roadway Luminaires	–	Pending
RENO-AEROLUX-SB-MW-DV-MCCT-ABA-R1-WH	Outdoor Pole/Arm-Mounted Area and Roadway Luminaires	–	Pending
RENO-AEROLUX-SB-MW-DV-MCCT-ABA-R1-BRN	Outdoor Pole/Arm-Mounted Area and Roadway Luminaires	–	Pending
RENO-AEROLUX-SB-MW-DV-MCCT-ABA-R2-BK	Outdoor Pole/Arm-Mounted Area and Roadway Luminaires	–	Pending
RENO-AEROLUX-SB-MW-DV-MCCT-ABA-R2-WH	Outdoor Pole/Arm-Mounted Area and Roadway Luminaires	–	Pending
RENO-AEROLUX-SB-MW-DV-MCCT-ABA-R2-BRN	Outdoor Pole/Arm-Mounted Area and Roadway Luminaires	–	Pending

Photometrics

Aerolux R1 at 5000K (150W, T3 Optics)

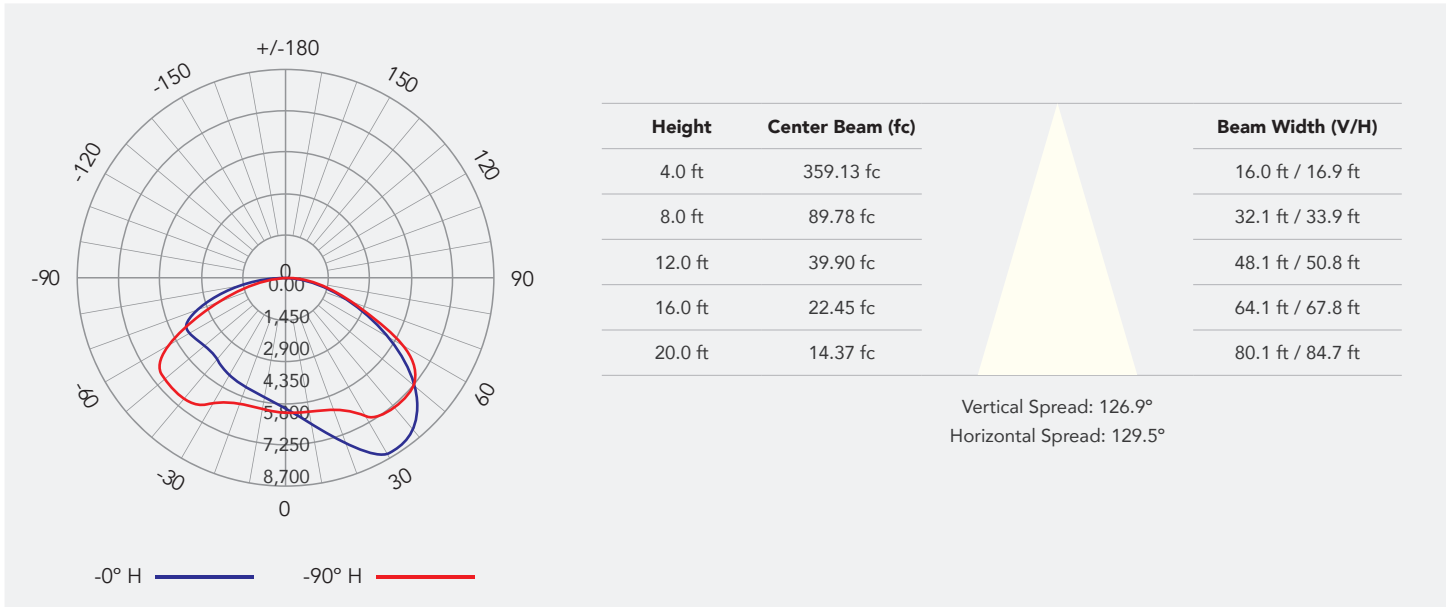

Aerolux R2 at 5000K (300W, T3 Optics)

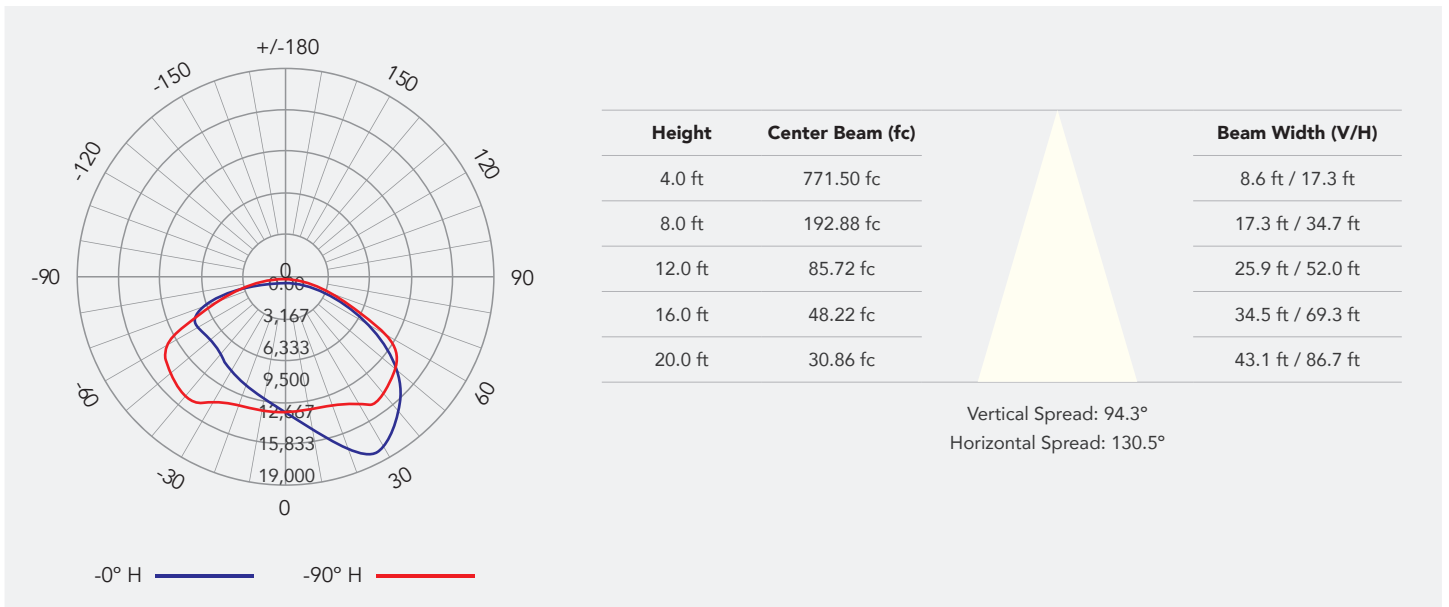

BeamFlex™

RENO Optical Technology Platform

BeamFlex™ is Reno Lighting's proprietary optical technology platform providing field-selectable beam distribution integrated within the luminaire. Beam angles are adjustable on site during installation or commissioning, eliminating the need for factory-specified fixed optics or post-installation optic replacement.

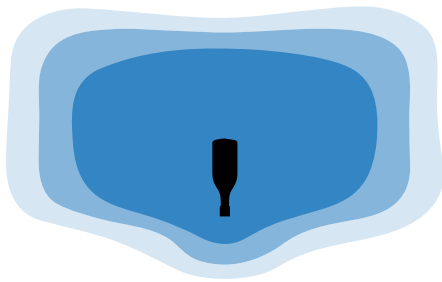

Type II (T2)
Light Distribution

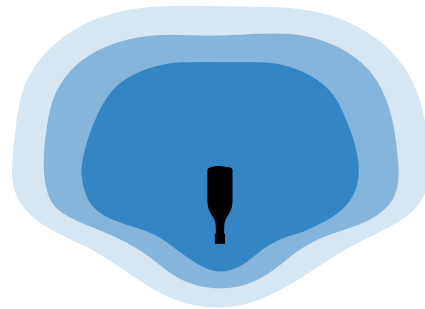

Type III (T3)
Light Distribution



Type IV (T4)
Light Distribution



Type V (T5)
Light Distribution

Field Settings

Selectable CCT | Optics | Wattages

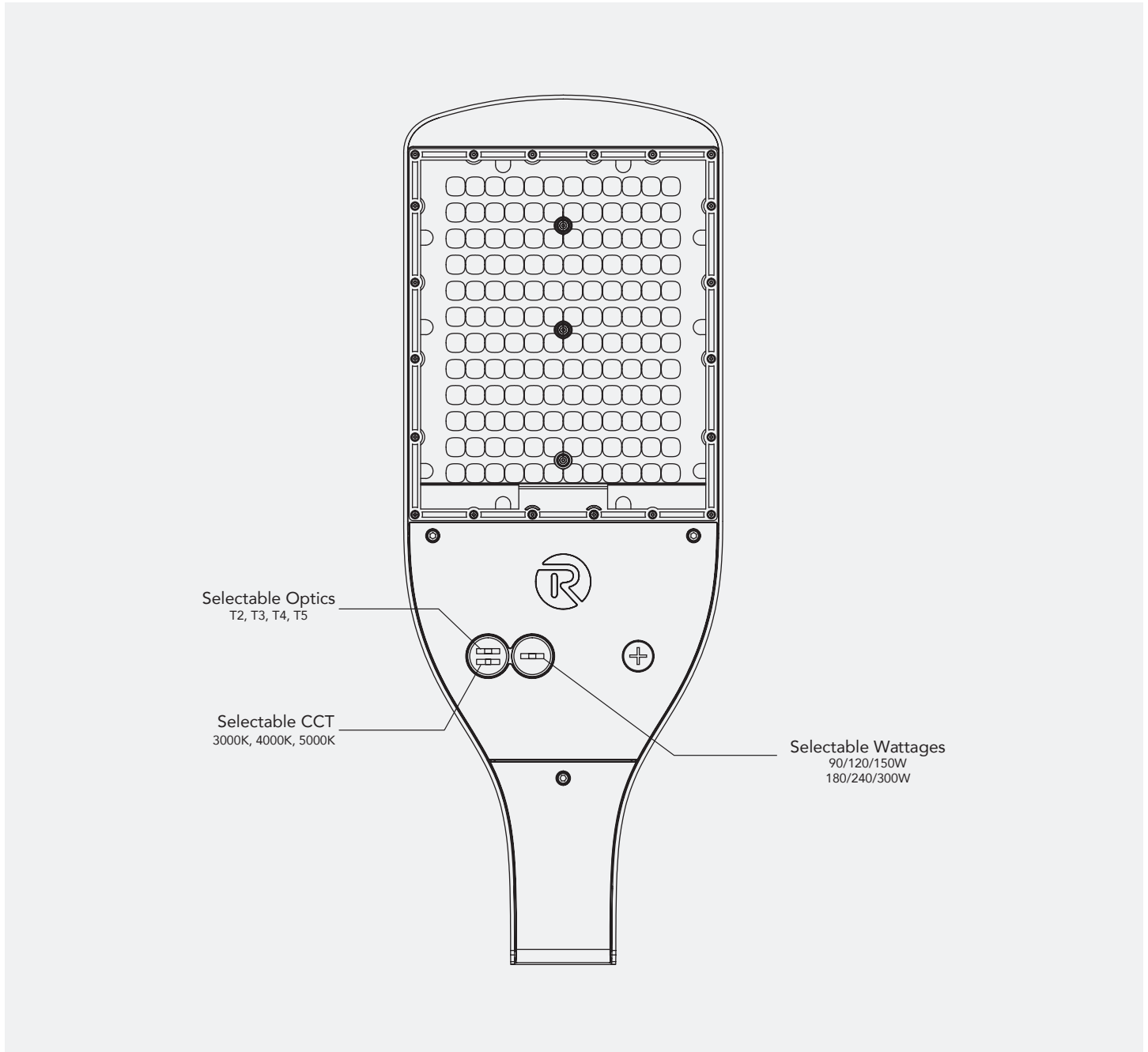

Dimensions

Aerolux Models: R1 | R2

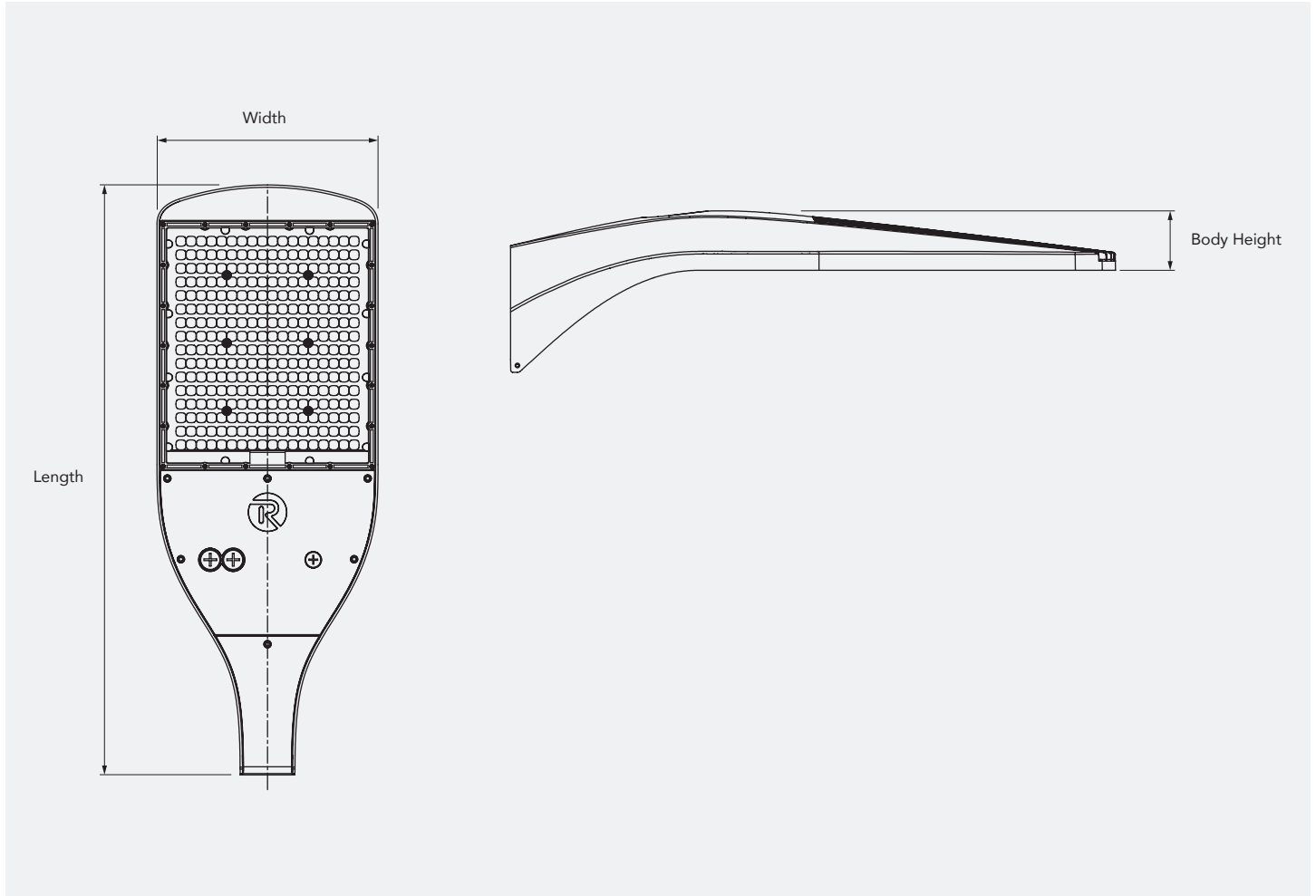

	Aerolux R1	Aerolux R2
Length	26.25" 666.8 mm	34.212" 869.0 mm
Width	9.63" 244.6 mm	12.82" 325.5 mm
Body Height	2.58" 65.4 mm	3.15" 80.0 mm

Pole Mounting

Round | Square Options



Mounting on Square Pole
 No adapter needed

Mounting on Round Pole
 Adapter included in box

EPA Rating

Model #	Tilt 0°	Tilt 45°	Tilt 90°
RENO-AEROLUX-SB-MW-DV-MCCT-ABA-R1-XXX	0.26	0.43	0.45
RENO-AEROLUX-SB-MW-DV-MCCT-ABA-R2-XXX	0.43	0.62	0.66

Accessories

House-Side Shields



House-Side Shield (black)

R59017

RENO-AEROLUX-HSS-R1-BK

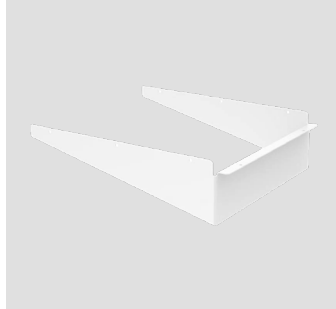

House-Side Shield (white)

R59018

RENO-AEROLUX-HSS-R1-WH



House-Side Shield (brown)

R59019

RENO-AEROLUX-HSS-R1-BRN



House-Side Shield (black)

R59027

RENO-AEROLUX-HSS-R2-BK

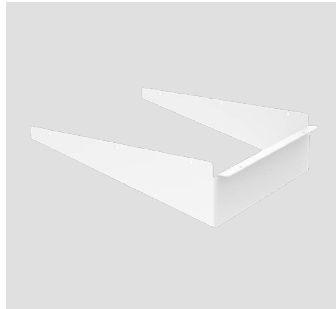

House-Side Shield (white)

R59028

RENO-AEROLUX-HSS-R2-WH



House-Side Shield (brown)

R59029

RENO-AEROLUX-HSS-R2-BRN

Order #	Model #	Description
R59017	RENO-AEROLUX-HSS-R1-BK	House-Side Shield for R1 Black Finish
R59018	RENO-AEROLUX-HSS-R1-WH	House-Side Shield for R1 White Finish
R59019	RENO-AEROLUX-HSS-R1-BRN	House-Side Shield for R1 Brown Finish
R59027	RENO-AEROLUX-HSS-R2-BK	House-Side Shield for R2 Black Finish
R59028	RENO-AEROLUX-HSS-R2-WH	House-Side Shield for R2 White Finish
R59029	RENO-AEROLUX-HSS-R2-BRN	House-Side Shield for R2 Brown Finish

Accessories

Remotes and Standalone Sensors



Microwave Sensor
R71002
RENO-SENSOR-MW-H



Photocell Sensor
R72001
RENO-SENSOR-PC-S



Photocell Sensor (black)
R72002
RENO-SENSOR-PC-S-BK



Remote for Standalone Sensors
R73002
RENO-REMOTE-H



Remote for Standalone Sensors
R73005
RENO-REMOTE-H-ECO



Bluetooth PIR / Photocell Sensor
R75001
RENO-RS-JK-BPDN-12V



Bluetooth Microwave Sensor
R75002
RENO-RS-JK-BMWM-12V

Order #	Model #	Description
R71002	RENO-SENSOR-MW-H	Microwave Sensor
R72001	RENO-SENSOR-PC-S	Photocell Sensor
R72002	RENO-SENSOR-PC-S-BK	Photocell Sensor (black)
R73002	RENO-REMOTE-H	Remote Control for Standalone Sensors (With Screen) Note: Only 1 needed per project
R73005	RENO-REMOTE-H-ECO	Remote Control for Standalone sensors (Without Screen) Note: Only 1 needed per project
R75001	RENO-RS-JK-BPDN-12V	Bluetooth PIR/Photocell sensor
R75002	RENO-RS-JK-BMWM-12W	Bluetooth microwave sensor